



International Luge Federation

**IRO
INTERNATIONAL
LUGE REGULATIONS
- NATURAL TRACK -**

2014 Edition

www.fil-luge.org

Approved at the 62th FIL Congress on June 20, 2014
in Innsbruck / Austria

**International Luge Regulations
Natural Track 2014**

§ 1	General Regulations	3
§ 2	FIL Competitions, Awarding	4
	1. FIL Competitions	4
	2. Procedure for the Awarding of FIL Championships and International Competitions.....	5
§ 3	Disciplines, Competition Runs, Regulations for Eligibility, Ranking	6
	1. Disciplines	6
	2. Competition Runs	6
	3. Regulations for Eligibility	6
	4. Age Requirements	7
	5. Start Order.....	8
	6. Authorization to Participate in Training.....	8
	7. Authorization to Participate in Competition	8
	8. Ranking.....	8
§ 4	Race Administration, Jury, Technical Delegates, International Judges	10
	1. Race Administration	10
	2. Jury	11
	3. Technical Delegates.....	11
	4. Combined Task of the Jury and Technical Delegates.....	12
	5. International Judges.....	12
§ 5	Sled and Equipment	13
	1. General Regulations on the Sled	13
	2. General Regulations on the Equipment.....	16
§ 6	Medical Services	18
	1. General Regulations	18
	2. Responsibilities.....	18
	3. Evacuation of Injured Persons.....	18
§ 7	Advertising Regulations.....	19
	1. Applicability, Measuring Procedure.....	19
	2. Race Clothing	19
	3. Safety Helmets.....	19
	4. Goggles	19
	5. Caps, Headbands and other Headgear.....	19
	6. Start Numbers	20
	7. Racing Shoe.....	20
	8. Gloves	20
	9. Sled	20
	10. Athlete.....	20
	11. Forbidden Advertising.....	20
§ 8	Training,	21
	1. International Training Courses	21
	2. Official Training	21
	3. Inspections	22

§ 9	Race Preparation	22
	1. Entries	22
	2. Entry Fee	22
	3. Draw	22
§ 10	Race Program, Results	24
	1. Start	24
	2. Inspections at the Start and Finish	25
	3. Sliding Rules, General Rules	25
	4. Finish	26
	5. Timing	26
	6. Results	27
§ 11	Protests	28
	1. Reason for a Protest	28
	2. Procedure	28
	3. Settlement	28
§ 12	Awarding of Titles, Awards Ceremony	29
	1. Titles for World Championships	29
	2. Titles for Continental Championships	29
	3. Awarding of Titles in case of a Reduction of Runs	29
	4. Certificates	29
	5. Medals	30
	6. Pins for Competitors and Officials	30
	7. Gifts of Honor and Remembrance	30
	8. Awards Ceremony and Conclusion of the Event	30
§ 13	Concluding Regulations	31
Supplements:		
	1. Regulations for Natural Luge Tracks	32
	2. Rules for Instruction of International Judges	36
	3. Parallel Competition with Nations Cup	39
	4. Sample for Cover Page	44
	5. Regulations for Audio-Visual Media Rights	45
	6. Junior World Cup	47
	7. World Cup with Nations Cup Natural Track	48
	8. Start Procedure Team Competition	51

§ 1 General Regulations

- 1.1 The International Luge Regulations for Natural Track (IRO Natural Track) include the regulations for the proper staging of all competitions of the sport natural track luge including championships and international FIL competitions. It is also valid for luge competitions during Olympic Winter Games (OWG).
- 1.2 The sanctioning body and event organizers as well as the participating nations, sport clubs, teams, athletes, judges and all assigned helpers are obliged to adhere to the following regulations and use them during the staging of competitions on natural tracks during Olympic Winter Games, FIL Championships and international competitions, provided that there are no IOC regulations, FIL statutes or resolutions of FIL bodies ruling against it.
- 1.3 Athletes registered by their National Federations (NFs) can participate in all FIL competitions if they have a valid licence. The licences are filled out by the respective NF on behalf of the FIL and are newly signed by the President of the respective NF or by a person authorized by him/her every season. With the signature of the National Federation's representative, it has to be confirmed that the athlete
- is a member of his/her federation or one of its associated club
 - that he/she is insured for practicing the sport of luge also in foreign countries,
 - that he/she possesses a medical certificate that is based on a medical examination conducted during the preceeding 12 months and a subsequent medical examination in the event of a serious injury, which states that from a point of view of sports medicine, he/she is fit for participating in the sport of luge, and
 - that he/she has received sufficient training so as one could expect the athlete to be able to safely navigate luge tracks during competitions and official training..
- The licence only becomes valid after the athlete declares in writing that they bindingly acknowledge the statutes and regulations of the FIL, especially the IRO, the Law and Procedure Regulations of the FIL and that they have knowledge of the contents of all regulations. The licence must be submitted to the chairperson of the jury prior to each competition.
- 1.4 The event organizer authorized to stage FIL competitions is obligated to secure liability insurance for the entire duration of the competition in which the extent of the coverage is to be regulated through a written agreement. Any liability of the FIL will be explicitly excluded.
- 1.5 All NFs have the right to apply for the staging of FIL Championships and international competitions according to the IRO Natural Track regulations. With the application to host an event, the respective NF acknowledges the IRO regulations for Natural Track and all other FIL Regulations. Deviations from these regulations are possible only if the responsible FIL bodies according to the statutes explicitly approve these.
- 1.6 Athletes, FIL officials, National Federations, physicians, coaches, managers and other participants in the sport of luge are obligated to comply with the Anti-Doping Code of the FIL during and outside competition.
- 1.7 The word "athlete" used in the IRO Natural Track includes both, female and male competitors.
- 1.8 The sport year of the FIL starts on July 1st and ends on June 30th of the following year.
- 1.9 Violations against the regulations of the IRO Natural Track result in disqualifications and/or other sanctions, which are specified in the Law and Procedure Regulations.

1. FIL Competitions

1.1 Luge competitions during Olympic Winter Games (OWG)

1.2	FIL Championships	<u>Rotation</u>
1.2.1	World Championships (WCh)	- in odd numbered years
1.2.2	World Junior Championships (WJCh)	- in even numbered years
1.2.3	Continental Championships	- in even numbered years
	Exception: North American Championships	- annually
1.2.4	Continental Junior Championships	- in odd numbered years

All Championships are numbered consecutively:

- 20th WCh 2015** (World Championships)
- 10th WJCh 2016** (World Junior Championships)
- 26th ECh 2016** (European Championships)
- 33rd EJCh 2015** (European Junior Championships)

Consecutive titles are awarded even if Championships are cancelled.

1.3 International Competitions

- 1.3.1 World Cup (WC) – minimum of 5 races.
Double World Cups are possible in exceptional cases. A parallel competition is possible.
- 1.3.1.1 The number of competitions, the locations as well as the dates are proposed by the Sport Commission and confirmed by the Executive Board.
- 1.3.1.2 During all World Cups, athletes who are registered by their NFs with the event organizers are eligible to participate in the event if they meet the stipulated requirements (see § 3).
- 1.3.1.3 Cost Subsidy
For each World Cup, the FIL provides a subsidy for accommodation for a maximum of two athletes per NF.
- 1.3.2 Junior World Cup in Luge
- 1.3.2.1 The number of competitions, the locations as well as the dates are proposed by the Natural Track Sport Director and confirmed by the Executive Board.
- 1.3.2.2 In general, the Junior World Cup in Luge should serve to develop aspiring young talent in Natural Track luge.
- 1.3.2.3 During all Junior World Cups in Luge, athletes who are registered by their NFs, their regional associations and/or clubs with the event organizers are eligible to participate in the event provided that they meet the stipulated requirements (see Supplement 6).
- 1.3.3 FIL Youth Games
- 1.3.3.1 During FIL Youth Games, athletes who are registered by their NFs, their regional associations and/or clubs with the event organizers are eligible to participate in the event they meet the stipulated requirements (see § 3).
- 1.3.3.2 The duration of the event is limited to 3 days.
- 1.3.4 Other International Competitions
International competitions are competitions in which athletes from at least two NFs participate.

2. Procedure for the Awarding of FIL Championships and International Competitions

- 2.1 The Congress awards the FIL Championships a maximum of 4 years in advance.
The award is made upon written application by the NF.
The application has to be submitted to the President of the FIL a minimum of eight weeks prior to the Congress.
Two years prior to the championships, either a homologation certificate for the track or a positive endorsement by the chairman of the Natural Track Construction Commission must be submitted.
If neither of the above-mentioned requirements is fulfilled, the event may be awarded to another applicant.
- 2.2 The Executive Board awards the World Cups upon application by the NFs or in agreement with them (provided the homologation certificate is available).
- 2.3 All other FIL competitions are confirmed by the Executive Board.

1. Disciplines

Championships and competitions are staged in the following disciplines:

- Women - Singles
- Men - Singles
- Doubles
- Team competition.

The organizer, in conjunction with the Natural Track Sport Director, will decide whether the team competition will be staged prior to or after the singles competitions.

If it is staged prior to the singles competitions, those athletes who did not participate in the team competition will receive an additional training run.

2. Competition Runs

	Singles	Doubles
WCh / WJCh	3	2
Continental Championships	2	2
International Competitions	2	2

3. Regulations for Eligibility

	Women	Men	Doubles
3.1 World Championships	4+1	6+1	3+1
3.2 Continental Championships	4+1	6+1	3+1
3.3 Continental Junior Championships	4	6	3
3.4 World Cup	3	4	2

Continental Championships can be held as a "Race in Race" within a World Cup (both Junior and General Class). Participants in a continental Championships held within a World Cup must be identified by name at the time of the World Cup registration.

Exception: With North American Championships, the number of participants is not restricted.

During World and Continental Championships, the title holders have an additional right to start (+1) in the doubles discipline, only with the athletes of the team which have won the title.

3.5 During Continental Championships, all nations are allowed to start, however, only athletes from the event organizer's continent can win the first three places. Therefore, separate final result lists have to be provided.

3.6 Junior World Cup - Number of Participants

There is no restrictions on the number of participants, however Youth Class athletes cannot register in the Junior World Cup.

3.7 **FIL Youth Games - Number of Participants**

There is no restriction of the number of participants for:

- Novice I singles
- Novice II singles
- Youth I singles
- Youth II singles

4. Age Requirements

4.1 FIL competitions are staged in the following age classes:

- Novice I
- Novice II
- Youth I
- Youth II
- Junior I
- Junior II
- General Class

4.2 Year of birth for the separate age classes:

Novice I	Minimum Age	Year of Event - 7
Novice I	Maximum Age	Year of Event - 8
Novice II	Minimum Age	Year of Event - 9
Novice II	Maximum Age	Year of Event - 10
Youth I	Minimum Age	Year of Event - 11
Youth I	Maximum Age	Year of Event - 12
Youth II	Minimum Age	Year of Event - 13
Youth II	Maximum Age	Year of Event - 14
Junior I	Minimum Age	Year of Event - 15
Junior I	Maximum Age	Year of Event - 17
Junior II	Minimum Age	Year of Event - 18
Junior II	Maximum Age	Year of Event - 20
General Class	Minimum Age	Year of Event - 21

(minimum age and maximum age = year of birth)

For a competition taking place at the beginning of the season (July 1st - December 31st), the athlete falls in the age class valid for him/her during a competition held the following 1st of January.

4.3 For championships and international competitions in the general class, athletes must have reached the minimum age (year of the event minus 15).

5. Start Order

Prior to the draw or assignment of the start numbers, the start order of each discipline and/or classes must be determined:

- Women’s Singles
- Men’s Singles
- Doubles
- Team Competition
- Seeded Athletes

6. Authorization to Participate in Training

An athlete is authorized to participate in training if:

- the athlete has not started for another nation during the respective sport year,
- a valid license is submitted, and
- the age class regulations are adhered to.

During Championships and World Cups one athlete per singles discipline as well as one additional doubles team may start in addition to the athletes named under § 3.3.

All participants in doubles can also take one training run as singles.

After the training run the team captains must identify which athlete is to be removed.

7. Authorization to Participate in Competition

An athlete is authorized to start in a competition if he/she participated in the training and he/she is not engaged as an official during the same competition.

8. Ranking

8.1 World Cup

8.1.1 Generally six races are held per season, and in some cases, double World Cups and/or a parallel competition are allowed.

Since doubles are ranked as a team, any change of athletes results in a new team ranking.

8.1.2 For the results achieved in a WC competition, the following points per competition are awarded:

Men / Women / Doubles:

1st Place	100 Points	15th Place	26 Points	29th Place	12 Points
2nd Place	85 Points	16th Place	25 Points	30th Place	11 Points
3rd Place	70 Points	17th Place	24 Points	31st Place	10 Points
4th Place	60 Points	18th Place	23 Points	32nd Place	9 Points
5th Place	55 Points	19th Place	22 Points	33rd Place	8 Points
6th Place	50 Points	20th Place	21 Points	34th Place	7 Points
7th Place	46 Points	21st Place	20 Points	35th Place	6 Points
8th Place	42 Points	22nd Place	19 Points	36th Place	5 Points
9th Place	39 Points	23rd Place	18 Points	37th Place	4 Points
10th Place	36 Points	24th Place	17 Points	38th Place	3 Points
11th Place	34 Points	25th Place	16 Points	39th Place	2 Points
12th Place	32 Points	26th Place	15 Points	40th Place	1 Points
13th Place	30 Points	27th Place	14 Points	41st Place	and continuing
14th Place	28 Points	28th Place	13 Points		with 1 point each

The winner of the overall World Cup is the athlete who has accumulated the highest number of points. In case of a tie in the final ranking, first the best achieved results (1st place, 2nd place etc.) and then the better ranking in the final competition are used as the tie breaker.

8.1.3 **Nations Ranking**

For the nations ranking, the points of all athletes from a NF are totaled according to the overall World Cup ranking.

After each World Cup, an intermediate result will be drawn up for the individual ranking and the nations ranking.

8.2 **Junior World Cup in Luge**

8.2.1 The Junior World Cup in Luge is awarded according to the World Cup regulations (§ 3.8.1.2). Points are awarded for the Junior World Cup. The rules can be found in Supplement 6.

8.3 **Team Competition**

8.3.1 A team must consist of a woman, man, and a doubles pair (total of four athletes per nation).

Teams with athletes from different nations are not allowed. This competition has one competition run.

Start order: woman, man, and doubles

The team with the fastest total time is the winner.

Nations can have different team members at each race.

8.3.2 At World and Continental Championships, a maximum of 2 teams per NF are allowed. At other FIL competitions only one team per NF is permitted. At WCh, Continental Championships, and World Cups, at least 5 nations must enter a team otherwise the competition is not held.

8.3.3 Team competition points are only added to the Nation's Ranking.

1. Race Administration

The race administration includes the Race Director, Start Leader, Finish Leader, and Chief of Track.

1.1 Race Director

1.1.1 The Race Director is fully responsible for the staging of the competition.

- 1.1.2 For the training and the competition, the Race Director declares the track open, if
- the confirmation by the first Technical Delegate has been submitted,
 - all officials have taken their posts and the technical equipment has been found to be in working order after examination and/or testing,
 - the medical services are present,
 - the communication equipment is available
 - all regulations of the IRO have been followed.

1.1.3 If the Jury or the Technical Delegates detect deficiencies which influence the proper staging of the event, the Race Director has to have the deficiencies remedied.

1.1.4 If accidents occur or if the technical equipment fails, the Race Director must close the track.

1.1.5 The Race Director has the right to refer any athlete to the race doctor for a medical assessment if this athlete is injured or ill or if, for any other reason, his/her start involves a specific risk to his/her health or life. If the race doctor confirms a specific risk to the health or life of the athlete in writing, the Race Director is entitled to withdraw the permission to start in official training and/or competition from any athlete.

1.1.6 The Race Director must inform the chairperson of the Jury and of the TDs of all incidents.

1.1.7 In case of infractions, the Race Director will make the initial necessary decisions.

1.1.8 Should the nominated Race Director fail to implement the FIL directions and acting on his own authority contradict the IRO or FIL directions, it is possible that this Race Director be divested of office by the responsible FIL representative in accordance with the Jury. Should the nominated Race Director for some reason not be available or should he/she have to be replaced during the staging of a competition, the Finish Leader will take over the post until the nomination of a new Race Director. The new Race Director to be nominated will be appointed by the event organizer in cooperation with the Jury.

1.1.9 The team captains' meetings are conducted by the Race Director, the Natural Track Sport Director or the responsible FIL representative.

1.2 Start Leader

1.2.1 The Start Leader is responsible for overall supervision of the start area.

He/she is in charge of testing the sled and equipment of the athletes and is to supervise the start process.

1.2.2 The Start Leader shall immediately notify the Race Director of any infraction of the rules.

1.2.3 A start during a competition will not be permitted, if any violations against the IRO are known.

1.2.4 Should a start during a training not be granted for safety reasons (§5 1.4.7, § 5 2.2, §5 2.3 and § 5 2.4.1), the athlete has to be assessed as "not started". This would not result in a disqualification. The report for this training run would show the abbreviation "n.start."

1.3 Finish Leader

1.3.1 The Finish Leader monitors proper arrival of the athletes at the finish.

1.3.2 The Finish Leader shall immediately notify the Race Director of any infraction of the rules.

1.4 Chief of Track

1.4.1 The Chief of Track is responsible for flawless maintenance of the track during training and competition.

1.4.2 He/she must immediately report reasons for not using the track to the Race Director.

2. Jury

2.1 Appointment and composition

- 2.1.1 For FIL Championships, all three members of the Jury will be appointed by the FIL Executive Board.
- 2.1.2 In case of the staging of a FIL competition (including WC), the authorized NF may propose three candidates and three substitute candidates for the Jury to the FIL Executive Board.
- 2.1.3 The proposed candidates must be members of a NF and must have the International Judges License.
- 2.1.4 The decision on the appointment to the Jury will be confirmed in writing to the NF, the event organizer, and the nominated judges.
- 2.1.5 The Jury includes three members and one of them is the appointed chairperson. During FIL Championships and World Cups, the chairperson of the Jury shall be appointed by the FIL Executive Board.
- 2.1.6 Only one member of the Jury may be a member of the NF hosting the FIL competition. During FIL Championships and World Cups, the three Jury members must belong to three different NFs.

2.2 Duties

- 2.2.1 The Jury is the highest authority of a competition. In accordance with the IRO, the Jury is given decision-making power for the duration of a competition.
- 2.2.2 Members of the Jury are not permitted to assume any function or position as a race official during an event.
- 2.2.3 Along with its supervisory duties, the Jury makes a decision on all written protests with a simple majority vote.
- 2.2.4 Each member of the Jury has access without prior notice to all technical equipment and facilities which are necessary for the staging of an event.
- 2.2.5 The Jury must be available from the beginning of training.
- 2.2.6 If a Jury member is not able to participate, the rest of the members in conjunction with the leader of the event organization decide upon the assignment of a new Jury member.

3. Technical Delegates

3.1 Appointment and composition

- 3.1.1 The Technical Delegates act on behalf of the FIL. They assist the event organizer with their expert knowledge, and through their supervision and inspections, they guarantee that the regulations of the IRO are followed. One of the Technical Delegates is the appointed chairperson.
- 3.1.2 For FIL Championships, the three TDs are appointed by the FIL Executive Board.
- 3.1.3 For all other FIL competitions, the FIL Executive Board appoints one (1) TD.
- 3.1.4 A substitute TD can be named by the Vice President Natural Track.

3.2 Duties

- 3.2.1 The Technical Delegate has access without prior notice to all technical facilities and equipment necessary for the staging of an event.
- 3.2.2 During training, the Technical Delegates, in concurrence with the Race Director, must ensure the athletes an opportunity to have their sleds and equipment inspected.
- 3.2.3 During training and competition, the Technical Delegate may carry out additional inspections on the sled and equipment in coordination with the Race Director.
- 3.2.4 Before each training and competition run, the Technical Delegates must inspect the race course and the facilities, and it is the responsibility of the chairperson of the TDs to inform the race director that the race course is clear if the inspection they carried out earlier justifies this. A

written record declaring the track open is only prepared at the beginning of each training or competition day.

At FIL Championships in the General Class and at World Cups, the elected Athletes' Representative or his/her substitute should be included by the TD in the track inspection prior to the first training.

The Athletes' Representatives shall take part in an advisory capacity.

- 3.2.5 In cooperation with the Race Director and the Chief of Track, the Technical Delegates must ensure that during a competition heat, the track conditions are kept as consistent as possible.
- 3.2.6 The Jury or the Race Director is to seek the expert opinion of the Technical Delegates in regard to various decisions, protests and so forth.
- 3.2.7 The TDs must possess an International Judge License.
- 3.2.8 The chairperson of the TDs must fill out the TD report, have the FIL representative sign it and send it according to the distribution list.

4. Combined Task of the Jury and Technical Delegates

Prior to all competitions, the Race Director, the chairperson of the Jury, and the TD shall determine the action plan for the jury and the TDs. In addition, the Race Director must debrief with the race doctor and the medics.

5. International Judges

- 5.1 During FIL competitions the Jury members, the Technical Delegates, the Race Director, the Start Leader, the Finish Leader, the Chief of Track and those judges who perform the inspection measurements, must possess a FIL International Judge License.
- 5.2 The NFs must provide instruction for judges in order to acquire the International Judge License.
- 5.3 NFs which have no internationally approved judges to carry out FIL competitions must request international judges from the FIL for these competitions.
According to the FIL travel cost reimbursement plan, compensation is to be paid by the NF hosting the event.
- 5.4 Competition officials are forbidden to participate as athletes in the competition at which they are officiating.

1. General Regulations on the Sled

1.1 Sled

The sled must have two separate runners.

The primary components of the sled are:

- 2 runners
- Sling seat or pod seat
- 2 steels
 - The steels must be neither divided crosswise nor be flexible.
 - The outside edges of the steels must be rounded.
- 2 undivided bridges
 - Only metal bridges are allowed
- 2 hand guards
- 1 set of reins

Parts welded together that are inseparable are allowed: this is in effect within the area of measurement E (300 mm).

The largest vertical, horizontal, or lateral cross-section of a bridge which is vertically, horizontally, or laterally connected to a runner cannot exceed 15 mm (measurement I) within the area of measurement E (300 mm).

The vertical cross-section of a bridge which is horizontally and sideways connected to a runner cannot exceed 15 mm (measurement I), for doubles sleds 20 mm (measurement I).

It is allowed to angle the bridges which are welded together. Welding seams at the joints are permitted.

The connection from runner to runner must be one continuous piece between the attachment points to the runners.

All parts of the sled must be made accessible to the TDs and/or Jury members and must be available for checking without technical difficulty.

Any kind of covering over the attachment points and/or over construction features is not permitted.

1.2 Steering

Steering must result from the interaction of the above-mentioned primary components of the sled and may be supplemented by stabilizer bars and reins.

On a doubles sled, steering may be supplemented by foot supports for the back athlete.

Foot supports must be fastened to the upper edge of the wooden runner and must neither extend over the outer edge of the steel nor above the height of the forward bridge's middle section.

Mechanical braking devices are forbidden.

1.3 Weight of the sled

Novice male and female	12 kg
Youth male and female	12 kg
Junior male and female	14 kg
Women and men	14 kg
Doubles	20 kg

The weights stated above are maximum weights and include attached accessories.

- 1.4 **Measurements of the sled**
- 1.4.1 Measurement of the distance between the inner edges of the steels:
Maximum 450 mm
Maximum 400 mm for youth sled - Drawing F
- 1.4.2 Inner measurement of the runners between the two bridges:
Minimum 300 mm - Drawing E
Minimum 250 mm for youth sled - Drawing E
- 1.4.3 Width of the sled including handles and hand guards:
Maximum 600 mm - Drawing H
- 1.4.4 Height of the sled from the upper edge of the forward bridge hip support to the bottom of the sled:
Maximum 250 mm - Drawing D
- 1.4.5 Height of the middle section of the forward bridge:
Maximum 200 mm - Drawing C
- 1.4.6 Open angle of the steels:
Maximum 45 degrees for singles
Maximum 40 degrees for doubles
Maximum 40 degrees for the youth sled - Drawing A.
The open angle / the inclination of the steels must at no point exceed these degrees. The measurement is taken from the middle of the front bridge to the middle of the back bridge (measurement J).
The bridges of the novices' sled have to be inserted into the runners within 35 mm (measurement K) from above.
maximum width of the runners 35 mm – drawing K
maximum height of the runners 65 mm – drawing L
- 1.4.7 Hand guards on the singles and doubles sleds for all classes on the outside of the runners between the two bridges. (measurement J)
The measurement takes place from the middle of the front bridge to the middle of the rear bridge (measurement J)

Minimum 50 mm - Drawing G (from the inside edge of the steel surface horizontally to the outside)
Maximum 75 mm - Drawing B (from the hand guard edge vertically to the ground)
- 1.4.8 The drawings exclusively serve as illustration of the specified dimensions of the equipment according to the regulation. They do not play a role in the construction.

front bridges

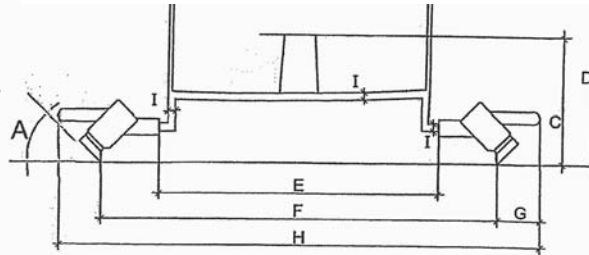
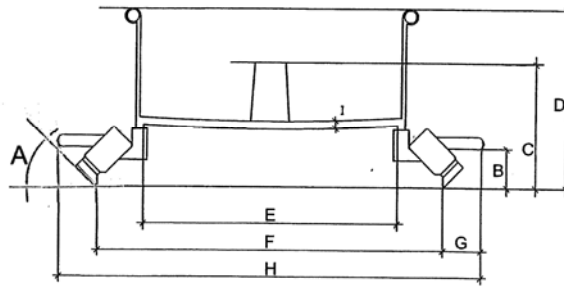

rear bridges

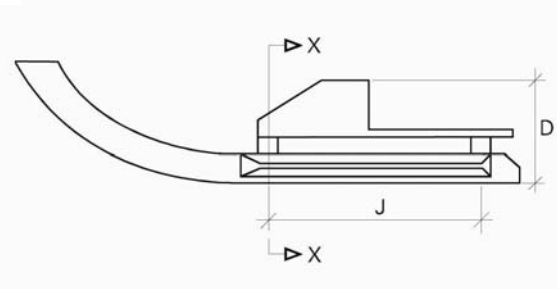
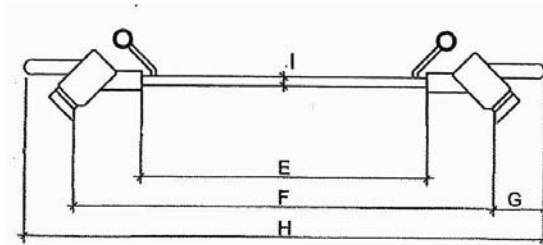

drawings 1-3: novices' sled – runners unshifted
front bridges

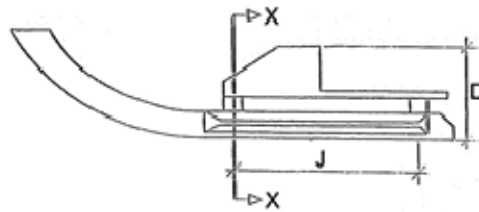
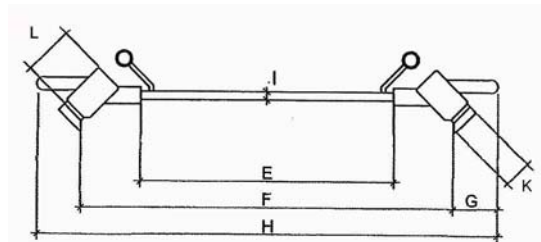
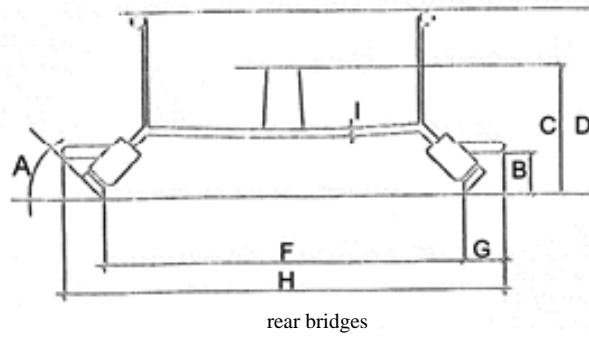

- 1.5 **Seat / Pod**
 1.5.1 The seat / pod in front of the forward bridge's middle section may have a maximum height of 200 mm.
 1.5.2 The seat / pod may not extend over the forward end of the runner.
 1.5.3 The seat / pod may not extend beyond the shoulders of the athlete.

2. **General Regulations on the Equipment**

- 2.1 **General**
 2.1.1 All items of race clothing, including helmet and racing shoes, must conform to or be adapted to the body contours of the athlete.
 Additional changes are not permitted.
 The wearing of visors is permitted.
 Aerodynamically shaped connections between the head and upper body are not permitted.

2.1.2 Each athlete must use proper race clothing to participate in a competition (including training).
Additional protective equipment (pads) must conform to the athlete's body contour, and is permitted with a maximum of 10 mm in thickness.

2.2 **Gloves**

Neither the design or effective length of the spikes on gloves are regulated.

2.3 **Safety Helmet**

The wearing of a safety helmet is mandatory for all athletes.

Each athlete who takes part in a FIL competition must wear a safety helmet which meets the safety regulations of his/her NF. The outer ear must be covered by the uniform helmet material. Constructions for letting in sound are allowed. (full shell with openings for hearing). See illustration.



example: safety helmet with full shell and ear openings

2.4 **Racing Shoes**

2.4.1 The racing shoes must have spikes which are firmly secured on a plate and/or a base which is firmly connected (bonding, welded seam, etc.).

The length and positioning of the spikes is not regulated.

2.5 **Racing Suit**

For racing suits, only textile fabrics may be used, the exterior surface of which must not be plasticized or otherwise sealed.

1. General Regulations

During the official training and race runs of any FIL competition, the following must be available:

- a) A race physician with knowledge of emergency care must be at the track.
- b) A minimum of one ambulance with one paramedic/ambulance officer. The ambulance must also be equipped with appropriate resuscitation equipment and be suitable/capable of accessing all roads around and along the track. The ambulance crew must be placed in such a way that, in accordance with the local conditions, immediate pick up of any ill or injured person is possible from all areas of the track.
Should the race physician and/or the ambulance be medically required, the race and official training must be interrupted until their services according to the above-mentioned regulations are again guaranteed.

2. Responsibilities

The race physician and/or the ambulance crew are responsible for the primary care of injuries or illnesses of the athletes. The race doctor must certify in writing to the Race Director when there is a specific risk to life or health by the participation of an athlete as a result of an injury or illness or for any other medical reason (§ 4 Section 1.1.5).

3. Evacuation of Injured Persons

The event organizers must guarantee that injured persons can be transported away from any point along the entire length of the track without obstruction or difficulties.

1. Applicability, Measuring Procedure

1.1 Applicability

All these regulations are in force during FIL competitions, as well as for media and PR activities and are applicable to athletes and officials.

1.2 Measuring

The size of a commercial marking or trademark is the surface within a line following the actual outline of the integrated marking.

If the trademark is integrated within an area of different color, the total area of the different color is to be measured.

The adherence to the proper size of the trademark will be under the responsibility of the NFs. At FIL competitions, the Race Director, Technical Delegates and Jury have the right to carry out inspection measurements at any time.

2. Race Clothing

Articles of clothing may carry manufacturers' identifications and/or trademarks of other sponsors.

The total surface area of the trademarks together on the clothing (except head coverings, gloves, and shoes) of one person shall not exceed 350 sq cm.

The complete surface can be divided into 8 parts at the most.

The complete surface of a single part may not exceed 100 sq cm.

The trademarks of the same sponsor may not appear one above the other or one beside the other.

The NFs may decide the placing of the trademarks.

The markings on the clothing will be measured when the clothing is not worn.

The respective NF is responsible for maintaining the advertising regulations.

(plus the specifications approved in 2005)

3. Safety Helmets

Athletes' safety helmets may display two (2) trademarks of the manufacturer with a maximum size of 15 sq cm, one each side, placed over the ears.

The advertising surface on the front of helmets may only be used by the FIL (60 sq cm).

A national emblem (max. 30 sq cm) is permitted on the helmet and also the name of the athlete (maximum twice and the height of the lettering is limited to a maximum of 15 mm) without obstructing the official FIL advertising.

4. Goggles

Goggle straps shall correspond to the commercially available design.

The width of a goggle's strap shall not measure more than 4 cm.

In the case of double straps, only one strap may carry the trademark.

5. Caps, Headbands and other Headgear

Caps, headbands and other headgear may each have a maximum of three (3) trademarks of the manufacturer and/or other sponsors, with a maximum total surface of 90 sq cm.

6. Start Numbers

Advertising labels on start number bibs are permitted. The advertising surface must be smaller than the section bearing the start number.

In doubles competition, both athletes shall wear start numbers.

During FIL Championships of the general class and during WCs, the start number bibs provided by the FIL sponsor have to be worn during the official training as well.

7. Racing Shoe

Racing shoes may only show one manufacturer's trademark on each shoe.

The size and quantity of the manufacturer's logo on the shoe must not exceed the size and quantity of a product which is publicly available.

8. Gloves

Gloves may only show one manufacturer's trademark on each glove, size 15 sq cm.

The trademark can be divided into two parts.

9. Sled

In addition to the manufacturer's trademark, a maximum of (five) 5 commercial trademarks may be displayed on the entire sled, of which a maximum of (two) 2 trademarks may be displayed on the bottom of the seat mat.

The size of the advertising surface on the bottom of the seat mat may not exceed 900 sq cm.

10. Athlete

Advertising with athletes is only allowed with the permission of the responsible NF.

The name, title and picture from the athletes can only be used once for each advertisement.

11. Forbidden Advertising

Provided there are no stricter national laws, following advertisement is prohibited:

1. on the athlete and sled: advertising for tobacco, illegal drugs or alcohol.
Exception: advertising for non-alcoholic beer and, regarding athletes of age (18), advertising for products with an alcoholic percentage of less than 10 %.
2. at the sports venue and on bibs: advertising for tobacco, illegal drugs or products with an alcoholic percentage of more than 10 %. The FIL Executive Board can allow an exception of this prohibition following a request from the event organizer or the venue operator.
3. advertising conveying religious, racial or any other discrimination.

1. International Training Courses

- 1.1 The NF that is holding FIL Championships must provide national or international training days to all NFs before the staging of the event, depending upon track conditions.
- 1.2 The staging of training days is strictly a matter of the NF. The terms of these training days are to be set up in the contract with the event organizer.

2. Official Training**2.1 Official Training Runs**

- 2.1.1 At least one forerunner must always be available at the start for each training run. The forerunner must not use the track as an after-runner at the end of any training run.

	Singles	Doubles
FIL Championships	minimum of 2	minimum of 2
World Cups	minimum of 1	minimum of 1
Other FIL competitions	minimum of 1	minimum of 1

- 2.1.2 The start order for the training runs is determined during the first team captains' meeting.

Doubles athletes who are allowed to train in the singles training start prior to the rest of the field (men).

- 2.1.3 Each athlete must participate in at least one training run in singles or one training run in doubles.

An athlete may participate in the competition runs also if he/she does not complete the training run on the full length of the course.

- 2.1.4 Reduction of the number of training runs

If conditions prevail which make it impossible for the competitors to complete their required training runs, e.g., warm wind, snowfall, etc., the Race Director in agreement with the Chief of Track and the chairperson of the TDs can interrupt training and set up a new training time.

In such a case, the Race Director shall determine the number of training runs to be completed following the confirmation of the chairperson of the TDs.

- 2.1.5 During training, in addition to the athletes mentioned under § 3.3.5, one additional athlete per singles discipline as well as one additional doubles team are allowed to start.

All participants in doubles can also take one training run as singles.

- 2.1.6 For the doubles' training, a separate time has to be arranged.

- 2.1.7 During the competition all unauthorized training on the track other than during the designated training times is forbidden.

- 2.1.8 The track is to be closed to all training activities (two) 2 days prior to the time specified in the competition invitation for the beginning of training.

- 2.1.9 In substantiated cases, with approval of the Jury, the Race Director may allow athletes who have arrived late due to no fault of their own, to complete the minimum number of training runs.

2.2 Timing

- 2.2.1 The times for each run are to be announced in writing with at least a start time, two intermediate times and a final time.

- 2.2.2 All training runs must be performed with electronic time keeping equipment.

Official training run times must be officially announced.

- 2.2.3 Neither Team officials or athletes are permitted to enter the official time keeping facilities.

- 2.2.4 Unofficial time-keeping equipment is only permitted during training and may only be erected in coordination with the Race Director and the chairperson of the TDs and must be situated a minimum of 20 meters away from any official time-keeping systems.

3. Inspections

Inspections at the start are also obligatory during training and must be performed on all equipment.

§ 9 Race Preparation

1. Entries

Registration for the athletes must be submitted to the organizers according to procedure and by the deadline shown on the race invitation.

2. Entry Fee

- 2.1 Entry fees for all athletes must be paid to the event organizer, who then issues a receipt. For all FIL competitions, the amount of the entry fee for each athlete in each discipline will be determined in Euro (€) by the FIL Executive Board. The entry fees remain the property of the organizer even when a NF withdraws the entry of one or more athletes.

3. Draw

- 3.1 Time and location of the draw are to be described in the invitation to the competition.
- 3.2 The Race Director is the chairperson of the draw. The Team Captains' meeting will be run by the Race Director, The Natural Track Sport director, or the FIL representative.
- 3.3 During the draw, the Jury Chairperson must be present.
- 3.4 The minutes of the draw must be recorded and signed by the Race Director and the chair person of the Jury.
- 3.5 During FIL Championships and competitions, bibs are to be used for start numbers, for both athletes of doubles teams. The start number must be visible on the chest and on the back. Start numbers bibs must be elastic, sleeveless, and adhere closely to the upper body and they shall not be exchanged. Taping of the start numbers at the bottom edge is only allowed to a maximum width of 5 cm. During the awards ceremony, the three winners must visibly wear their start number bibs.
- 3.6 The starting order of the athletes for the competition is drawn for each discipline during the first team captains meeting. The exchange of start numbers is not permitted.

- 3.7 The draw will be done only once before the beginning of training.
The draw of name and number must take place simultaneously and shall be in effect for all training runs and competition runs.
A draw by computer is permitted.
During FIL competitions in the general class and during the World Cups, the start numbers are assigned based on the rankings of the last World Cup standing (lower amount of points = lower starting number).
Start numbers for Athletes with 0 points who do not appear in the World Cup rankings are drawn first.
- 3.8 For the doubles, the names of the team members must be known before the draw.
- 3.9 The registration of the names for the doubles competition is binding.
- 3.10 **World Cup**
The start numbers are fundamentally no longer drawn.
The awarding of the start numbers during the 1st World Cup of the new season is done according to the final ranking of the World Cup of the previous season.
The athlete with the fewest or no WC points receives the start number 1, ascending up to the WC winner.
By introducing this system of awarding the start numbers during World Cup races, only athletes with the same number of points or athletes who do not have points need to be drawn.
For the 2nd WC race and subsequent WCs, the awarding of the start numbers will be based on the results of the current point results.
- 3.11 The start list is to be announced publicly and displayed at the start and finish. Sufficient copies of the start list must be made available to each team captain.

1. Start

1.1 Start Rules

All disciplines must start from a start ramp.

Start time and start order:

The start times and start order for the athletes must be clearly displayed at the start and at the finish.

Prior to training and competition, it is the responsibility of each athlete to inform themselves of the order and their respective start times.

During OWG, FIL Championships, WC and intercontinental competitions, one to three forerunners must start per race run.

Following an extended interruption at the start, a forerunner must start again prior to the continuation of the race. At the end of each race run, the forerunner must not use the track as an after-runner.

1.2 Call to Start

The beginning of each heat must be announced over the loudspeaker system along the track 15, 10, and 5 minutes prior to the first starter.

The call to the start follows the checking of the sled in the start area.

The athlete must go to the start within two (2) minutes of being called.

1.3 Command to start when "start is clear"

1.3.1 During FIL championships and World Cups it is only permitted to start with "start is clear". Only one athlete or one doubles pair is allowed to be on the track at one time.

1.3.3 The starter may only give permission to start when he/she has received "finish clear" from finish.

1.3.4 After the command "start is clear", the athlete must trigger the timing system within 20 seconds.

1.3.5 In case of an interruption the athletes preparation time is 1 minute.

1.4 Command to Start for minute starts

1.4.1 The command to start 10 seconds before the start is "Attention".

The last 5 seconds before the start are counted out as: "5-4-3-2-1-go".

Instead of a start command and the counting of the last 5 seconds by the starter person, an acoustic start clock may also be used.

1.4.2 The start is valid if the athlete has not crossed the start line earlier than 5 seconds ahead of the assigned start time.

1.4.3 An athlete who starts earlier than 5 seconds ahead of their assigned start time, has a false start and will be disqualified.

1.4.4 Should an athlete start later than 5 seconds after the assigned start time, his/her time for the run will be calculated as if he/she had started exactly 5 seconds after his/her assigned start time.

1.4.5 During FIL Championships and World Cups, the start is carried out with "start is clear", whereby only one athlete or one doubles team may be on the race course at the same time (refer to supplement 1).

1.5 False Start

If there is a "false start" and the fault does not lie with the athlete, the Start Leader immediately informs the Race Director who will give instructions for a new start.

As soon as the athlete is ready to start again, the Race Director will decide on the starting time of the run to be repeated.

1.6 Start Assistance

To gain speed through the assistance by others is forbidden during the training and the competition.

2. Inspections at the Start and Finish

2.1 At the start, the following checks will be made:

- Weight of the sled
- Temperature of the steels
- Measurements of the sled

Fastening of the start number.

All violations of the inspection measurements at the start must be recorded in a report.

After the official inspection measurements, the sled must not be removed from the start area any more (exception: interruption of the start).

Prior to each run, the weight of the sled is checked in the start area by means of a gauged scale.

One gauged weight with a minimum of 1kg must be available at the start.

The scale must register in 100 gram increments.

2.2 Temperature of the steels

2.2.1 At the start, 2 calibrated pyrometers must be made available for measurement.

One pyrometer is used for official measurement by the judge at the start; the second pyrometer is at the athletes' disposal for inspection measurement ahead of time and is operated by a judge or by a person appointed by the Technical Delegate.

The official temperature check of the steels, using approved equipment, is to be conducted in the start area.

Each steel is to be tested at each point where the runners are attached to the bridges.

In addition, it can be checked at any point of the steel located between the bridges.

After the steel temperature has been checked, they may not be heated again.

2.2.2 The temperature of the steels may not be greater than + 5 degrees C above the control temperature. The control temperature is established from a control steel located at a height of 1/2 to 1 meter from the ground level.

If the control temperature falls below -5 degrees C, the temperature of the steels may show 0 degrees C.

2.2.3 At the start, a control steel 50 cm long corresponding to the profile of a steel is to be set up as permanent equipment attached in a location sheltered from the sun, and is to be used as a basis for temperature measurement.

The temperature of the control steel is to be taken 30 minutes prior to the start and is to be repeated every 15 minutes from that time.

The results are to be posted in degrees with accuracy to one tenth of a degree on a notice board that is visible to everyone.

2.2.4 After the measurements, no more than 2 sleds at a time may be in the start area..

2.3 Measurement

2.3.1 Prior to each run, the sled is checked within the start area by the authorized judge and with the official FIL measuring device.

2.4 Inspections

Random inspections on the entire or part of the sled can be carried out by the Technical Delegate after the completion of a run.

3. Sliding rules, General Rules

3.1 Principle Rules

During all FIL Championships and FIL competitions, the competitor must travel on his/her sled from the start to the finish in a seated or reclined position. Interruptions caused by a crash on the track are not grounds for disqualification from the race. Competitions may be held in all weather conditions and in temperatures of down to -25 degrees centigrade. In the event of colder temperatures, the Race Director will decide as to whether or not to stage the competition after consultation with the Technical Delegates and the Team Captains.

3.2 **Departure from the Sled**

3.2.1 If an athlete is not able to bring his or her sled into a gliding motion after a crash due to insufficient slope in the course, snow conditions or other reasons, he or she may put the sled into motion by running with it before getting back on it.

3.2.2 Assistance by others is not allowed.

3.2.3 Any connection between the athlete and the sled during training or competition is only allowed to such an extent, that the connection will come loose by itself during a crash (Velcro).

3.2.4 It is forbidden to use a short-cut between start and finish.

3.3 **Modification and Exchange of the Sled**

It is permitted to exchange or to modify a sled between the runs of a competition.

3.4 **Behavior and conduct**

Each athlete and official participating in a competition must behave in a fair and sportsmanlike manner. The FIL Executive Board decides on misconduct and its punishment.

3.5 **Start Order**

3.5.1 During competitions that are staged in 2 runs, the start order for the 2nd run will be from the last place to the best place in all disciplines. After the completion of the 1st run, an intermediate result list has to be printed and must be posted at the start and finish.

3.5.2 During competitions that are staged in 3 runs, the start order in the individual disciplines will be determined as follows:

1st run first to last start number

2nd run last place to best place after 1st run

3rd run last place to best place after 2nd run

After the completion of the 2nd run, an intermediate result list has to be printed and must be posted at the start and finish.

3.6 **Interference**

3.6.1 If it is proven that an athlete is hindered by a person or another circumstance during a run, the athlete has the right to have a replacement run.

3.6.2 The Race Director determines the starting time of the run that must be repeated.

3.6.3 The time of the replacement run becomes official.

4. **Finish**

4.1 The finish is defined by the timing light and a finish line marked in color.

In addition, the finish must be marked with an arch-shaped advertising banner or a finish tape.

4.2 The athlete must pass the finish line in contact with his/her sled.

4.3 During doubles competitions, both athletes must pass the finish line in contact with their sled, however the order of the seating arrangement is not relevant.

5. **Timing**

- 5.1 Timing equipment with automatic and printing capabilities is required and must operate with one (1) start time, two (2) intermediate times and the finish time with an accuracy of 100th of a second.
The official start and finish timing lights have to be marked in color across the entire surface of the track during training and competition.
The timing equipment must be equipped in accordance with the timing manual.
- 5.2 The timing equipment must be tested and be ready for use at least one (1) hour prior to the beginning of each discipline.
- 5.3 In addition to the main electronic time-keeping system, supplementary timing equipment is required.
The supplemental time-keeping system may be either an electronic time-keeping system which functions independently from the main time-keeping system or it can be done manually.
If times are kept manually, the start clock must be synchronized with the finish clock before the beginning of the competition.
The times, including the time of day at the start and finish, must be entered in separate records along with the start number.
- 5.4 If a problem occurs with the timing equipment, the timer responsible must immediately inform the Race Director; and the Race Director shall interrupt the race for as long as it takes to guarantee proper timing.
The times of the auxiliary time-keeping shall be valid for athletes who completed a run during a failure of the time-keeping equipment.
- 5.5 Team officials and athletes are forbidden to enter the official time keeping facilities.

6. Results

- 6.1 The official results are the total of the times registered by the athletes in each individual heat (except team competition).
- 6.2 If two or more athletes register the same time for a run, they are awarded the same place.
- 6.3 The family (last name) and first name and start number of athletes who dropped out or who were disqualified are to be entered in the results lists with the times achieved up to that point.
Under "dropped out ", all applicable athletes are classified as:
- Did not start (**DNS**), e.g., sickness, injury
 - Not started (**n.start**) for safety reasons
 - Did not finish (**DNF**), e.g., did not finish due to a crash
 - Disqualified (**DIS**), e.g. violations against the IRO
- 6.4 The official results list must be signed by the Race Director and the chairperson of the Jury.
The names of the Jury members and of the Technical Delegates are to be listed.
The last and first names (full names) of all athletes are to be entered on the results list.
For the official results list, a cover page is to be used according to the sample.
- 6.5 At the end of the competition, the official results lists are to be distributed to each NF participating in the competition.
Immediately after the competition, one (1) original copy of the official results lists is to be provided to the FIL office, one (1) original copy is to be provided to the Natural Track Sport Director and to the FIL press official.

- 6.6 **Results and Timing Lists as Evidence**
The official measured times for each athlete must be immediately recorded in writing.
All documentary evidence is to be used for checking purposes and for possible protests.
All documentary evidence is to be kept by the organizer for the period of one year following the end of a competition.

§ 11 Protests

1. Reason for a Protest

If a participant believes himself/herself to be at a disadvantage due to factors which have occurred during official training, a race run, or at another time during a competition, his/her team captain has the right to protest. The flash from a camera does not provide a reason for protest. The Jury decides on all protests.

2. Procedure

- 2.1 Protests must be made in writing and must be signed by the team captain or the team captain's representative.
- 2.2 The protest must be given to the chairperson of the Jury and he must confirm the receipt with date, time and signature.
- 2.3 A protest fee of 60 Euro (or the equivalent value of a convertible currency) must be paid when the protest is submitted.
- 2.4 The written protest must be submitted within 10 minutes of the completion of the official training or competition heat or the other cause for the protest in question.
Should the reason for protest be a disqualification by the Race Director, the 10 minutes will be counted from the time of publication on the official information board after the end of the competition run.

3. Settlement

- 3.1 Concerning a protest, the Jury must meet within one (1) hour of the submission of the protest. If the reason for the protest is first known after the 10 minutes, the Jury must deal with the protest.
The final deadline is the conclusion of the competition (awards ceremony).
- 3.2 The Jury may call in all persons and items connected with the protest on the spot to help clarify the circumstances.
In the case of a protest, the jury must decide whether pieces of evidence (for example; films, video records, etc.) may be presented.
However, this material is only used to help make a decision.
- 3.3 The decision of the Jury in all protests is final. It may only be appealed against in accordance with the FIL Law and Procedure Regulations.
The decision must be given in writing to the person who protested.
- 3.4 The protest fee is returned in its entirety if the protest is decided in favor of the protesting party.
- 3.5 If the protest is denied, the protest fee is forfeited and is given to the organizers of the event.
- 3.6 If events or occurrences in violation of the IRO are discovered after the conclusion of the competition, the FIL Executive Board will make the decision in these cases.

1. Titles for World Championships

The following titles are to be awarded:

- 1.1 Men's Singles with the Title:
 "World Champion in Men's Singles"
- 1.2 Women's Singles with the Title:
 "World Champion in Women's Singles"
- 1.3 Doubles with the Title:
 "World Champion in Doubles"
Both competitors receive the same title and same awards.
- 1.4 Team Competition with the title
 "World Champion in the Team Competition"
The athletes receive the same title and the same awards.
- 1.5 The same titles and awards are used for World Junior Championships.

2. Titles for Continental Championships

The titles for Continental Championships are to be awarded with the same name as the corresponding competition.

3. Awarding of Titles in case of a Reduction of Runs

If the number of runs in a discipline is decreased, titles are only awarded if all athletes participate in at least one run.

4. Certificates

- 4.1 The certificate is a personalized and written confirmation of participation in a championship or competition. The following must be clearly noted on the certificate:
 - Name of the sponsoring NF
 - Type of championship or competition and the discipline in which the athlete participated
 - Name of the athlete
 - Level reached by the competitor in the final rankings
 - Signatures of the FIL representative, the chairperson of the Jury and the Race Director
 - Location and date of the event
- 4.2 Each athlete and official participating in a Championship must receive a certificate.

5. Medals

- 5.1 For FIL Championships, World Cups and Junior World Cups in Luge, medals are awarded for 1st – 3rd place.
- 5.2 The medals are provided as follows:
- By the FIL for World Championships, Junior World Championships, the Overall World Cup and the Overall Junior World Cup.
 - By the organizers for Continental Championships, Junior Continental Championships, individual World Cups and individual Junior World Cups in Luge.

6. Pins for Competitors and Officials

It is the obligation of the event organizers which stage World Championships, Junior World Championships, or Continental Championships to give pins or badges as gifts at no cost to athletes and officials.

7. Gifts of Honor and Remembrance

The event organizers may give gifts of honor and mementos to the participants.

8. Awards Ceremony and Conclusion of the Event

8.1 Procedure

The organizers are obligated to announce the winner immediately after the end of the competition in the finish area.

- 8.2 The awards ceremony for the winners as well as for the second and third place finishers in each discipline is to be made as follows:

- At the awards ceremony of all FIL Championships and competitions, the flags of the NFs for the champions and second and third place finishers must be raised and during the ceremony, the champion's national anthem must be played.
- If there are less than three ranked athletes in one discipline, this awards ceremony will not be staged.
- The staging of the official awards ceremony together with the flower ceremony is allowed.
- In the event of a tie for first place, the anthems of both competitors will be played in alphabetical order of family names.
- In the case of a tie in doubles, the family name of the front man is used.
- In the event of a tie, both flags will be raised.

- 8.3 The same procedure may take place at all international competitions.

- 8.4 The medals are presented to the top three finishers in each discipline by the FIL representative. In the representative's absence, the chairperson of the Jury awards them in a festive ceremony.

- 8.5 Each of the overall champions in the men's, women's and doubles disciplines receives the World Cup trophies.

The athletes placed second and third in the Overall World Cup receive trophies as well.

The top three ranked athletes in each discipline, as per total scoring, receive medals in gold, silver, and bronze.

The World Cup trophies, medals and certificates will be awarded at the awards ceremony for the last competition (World Cup Final).

World Cup trophies and medals are provided by the FIL.

- 8.6 The overall champions as well as the second and third places in the women, men and doubles disciplines receive trophies. These trophies are provided at the Junior World Cup in Luge Finals by the FIL.

- 8.7 The winners of the individual classes of the FIL Youth Games receive medals and honorary prizes.
- 8.8 At the conclusion of an awards ceremony and as a symbolic final act at FIL Championships, the FIL President or representative presents the FIL flag in a ceremonious manner to the representative of the NF which will stage the next FIL Championships.

§ 13 Concluding Regulations

1. The IRO Natural Track is available in German and English.
In case of a lack of clarity or contradictions, the German text is binding.
2. Resolutions regarding amendments and additions to the IRO Natural Track shall only be made by an ordinary Congress and require a simple majority, if the priority regulations of the FIL statutes do not state otherwise. Emergency motions to change the IRO Natural Track are only permitted in adherence to the FIL statutes.
3. In substantiated exceptional cases, changes in the IRO may be decided by the FIL Executive Board upon proposal by the appropriate expert commission. They will be presented for ratification at the next FIL Congress. The same is valid in case of controversial interpretations, contradictions and omissions in the regulations of the IRO Natural Track.
4. Changes and additions to the IRO Natural Track become valid at the beginning of the following sport year, July 1st.
5. This edition of the IRO Natural Track becomes valid on July 1st, 2014. At the same time, the former regulations of the IRO become invalid.

Supplement 1

Regulations for Natural Luge Tracks

1. General

All competitions sanctioned by the FIL shall be staged on tracks which are approved and commissioned by the FIL.

2. Definition of Natural Luge Tracks

Natural luge tracks are tracks which follow the natural terrain.

3. Tracks

- 3.1 Length: 800 m - 1200 m
Shortened tracks, on which international competitions may also be carried out with special permission of the FIL: from 400 m.
- 3.2 Width: minimum of 3 m.
- 3.3 Average drop: maximum of 13%
- 3.4 Maximum drop: 25%
- 3.5 Curve radii: minimum of 7 m calculated from the middle of the track.
- 3.6 Elements:
- left curve
- right curve
- sharp bends (left and right)
- curve combination
- straightaway.
- 3.7 Artificially-raised curves are not permitted.
- 3.8 The bottom of the curves should be horizontal.
- 3.9 The braking areas should be designed as flat as possible.
- 3.10 The finish outrun should be prepared like the track, which means as horizontal as possible, so that the athlete can safely brake after crossing the finish line.
- 3.11 The usage of cooling systems for refrigeration of the track is allowed in short portions of the track.
Agents and additives which will be used to support the refrigeration of the track's base must be environmentally-friendly in their nature, amount, and application forms.
- 3.12 At least 80 LUX must be set for the lighting power at luge tracks.
In order to meet the technical needs of television, the lighting power must be increased at specific sites in accordance with technical requirements.
In case of power failure, sufficient lighting, supplied from an independent source, must be guaranteed.

Power supplies must be inspected and certified by a licensed electrician and evidence submitted in writing to the Technical Delegate.

4. Condition of the Track

- 4.1 For the final training run, the track should be prepared as it will be for the first competition run. Between the competition runs, the surface of the track - if necessary - has to be repaired (e.g. outrun, braking areas etc.).
- 4.2 Should weather conditions, such as snow, thaw, etc., create unequal conditions for individual athletes during a race, the organizers must provide a readily available work crew of appropriate size to ensure the consistent condition of the track.
- 4.3 The decision on the start and rhythm of the sweeping of the track lies with the Technical Delegates in conjunction with the race director; it must be determined and announced to the team captains before each run. Alterations which happen through the immediate use of the track must be corrected within the run of a discipline or at least after the run and under the supervision of a TD.
- 4.4 Any conscious unauthorized change to the surface of the track during a race is forbidden.

5. Start Facilities

- 5.1 The track must be equipped with all the necessary start facilities to guarantee a flawless staging of the competition.
- 5.2 During competitions, the starting area must be closed off so that only persons with authorized access can enter the starting area (area approx. 200 m²).
The use of walkie-talkies and mobile phones is forbidden in this starting area. Smoking is forbidden within the closed-off starting area.
- 5.3 Individual components of the start facilities are:
- A horizontal iced surface on which the athlete may sit on his/her sled.
 - Length of the iced surface to the start handles: at least 2000 mm
 - Length of the iced surface from the start handles to the beginning of the descent: 500 mm. The transition from the start surface to the descent must be gradual.
 - Two start handles adjustable in height and width on either side of the start area which may be used by the athletes to increase the speed of their start.
 - From the ice to the upper edge of the handles at an equal height: 200 mm – 220 mm
 - Inside distance between the handles: adjustable between 740 mm – 800 mm
 - Length of the handle: at least 150 mm
 - Diameter of the handles: 27 mm
 - Upper surface of the handles must be grooved.
 - The construction of the handles must be so solid that it may not be bent upon the athletes' pull off.
 - The construction must be adjustable in a horizontal and vertical direction, so that the indicated measurements can be adhered to.
 - The timing equipment must be installed no further than 5 m after the start handles.
 - For the parallel competition, the start handles must also be mounted in line with each other.
- 5.4 If the start of a competition is carried out with the command "start is clear", the following additional facilities must exist:
- A signal horn which clears the track acoustically for the athletes.

- Lights (red-green) which clear the track visually for the athletes.
- A device which triggers the start clock simultaneously with the signal horn and green light, and which counts down from 20 to 0 seconds.
The athlete must trigger the timer at the start within these 20 seconds.
When the time-keeping is triggered, the start clock must stop automatically and the lights must switch to red.

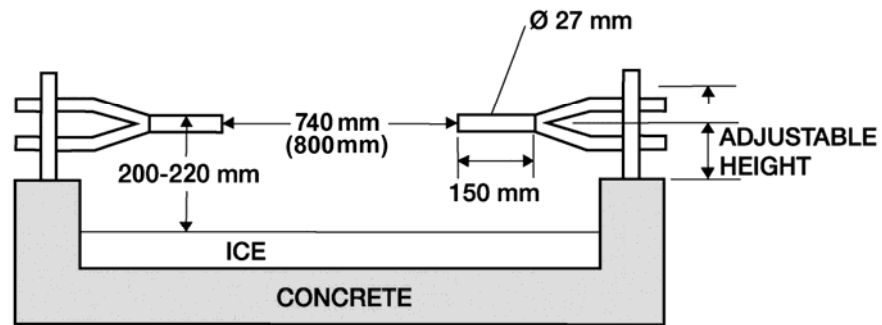
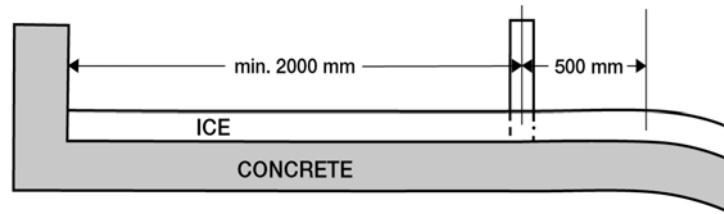

6. Safety Regulations

- 6.1 The track must be designed in such a way that exposed places are as safe as possible and meet the internationally-recognized safety standards by means of vertical protection walls and/or sufficiently large crash areas.
- 6.2 In exposed places, the protection walls must be built up in accordance with internationally accepted safety standards. The protection walls can be built with wood, glued wood, or plastic. The material has to be strong enough to withstand an impact.
- 6.3 The protection wall must follow the course of the curve.
- 6.4 The track must be declared clear for training and competition in writing. For this purpose, an official record is to be prepared with the following wording:
“The track has been inspected, especially its condition and the securing of dangerous sections. During the inspection of the track, it was determined that during regular usage of the track, including the finish run, no unusual safety risks will arise. Therefore the track is declared open.”
Place, date, time, and appropriate signatures must be included in this statement.

This record must be signed by the Technical Delegate and the Race Director prior to the use of the track.

- 6.5 A sufficient number of observation points equipped with walkie-talkies or other suitable means of communication, equipment for clearing the snow and red flags (when a minute start is carried out) have to be positioned along the track.

7. Construction Measures along the Track

- 7.1 Along the track, a broad path has to be provided in order to ensure that
- the athletes can get up to the start quickly,
 - the medical services can have quick access along the entire track,
 - the officials can observe the race,
 - the track crew can stand safely,
 - the spectators can walk up along the track.

- 7.2 There must be sufficient lighting conditions for night runs.
For further details, please refer to the track construction brochure.

- 7.3 A sufficient number of parking spaces must be created in the start and finish areas.

8. Homologation of Natural Tracks

- 8.1 The FIL Executive Board decides on official recognition and approval of a natural luge track for FIL Championships and FIL competitions after the track has been examined by representatives of the Track Construction Commission of the FIL.
No liability is assumed by the FIL when providing the expert opinion homologation.

- 8.2 For the homologation of a natural luge track, a request must be made to the chairperson of the FIL Natural Track Construction Commission.
He/she will then send suitable experts, who will carry out the homologation.

- 8.3 The full homologation procedure includes an examination of the planning documents, a track examination during summer construction and a homologation after the completion of the work.
The track operator assumes the expenses, which are to be settled according to the FIL regulations on travel expenses.

- 8.4 The track operators are to receive a homologation certificate concerning the homologation of a natural luge track, and all documents about the track will be stored in archives and included in a catalogue (against payment of a fee).

- 8.5 This procedure is to be applied not only for new constructions, but also for alterations.

- 8.6 The homologation is valid for 5 years and must be renewed after that.

Supplement 2

Rules for Instruction of International Judges

1. **Basics**

- 1.1 The training regulation of the FIL is an obligatory work document for all National Federations associated with the FIL.
- 1.2 During all FIL competitions, judges from the respective NFs may only be appointed if they possess FIL International Judge Licenses acquired in accordance with these instruction regulations.
- 1.3 The NFs associated with the FIL have the right to conduct the instruction and qualification of international judges under their own responsibility.
- 1.4 Only persons who are full members of NFs associated with the FIL may be admitted to instruction and qualification as an International Judge.
- 1.5 Issuing of the International Judge's License to the applicant is made after a valid examination and is not transferable.
- 1.6 The FIL may withdraw an International Judge's License for gross infractions, unsportsmanship-like ethics and morals in the conduct of ones duties.
The International Judge's license can also be withdrawn if after several years, the respective judge cannot prove that he has officiated and/or has not participated in refresher or repetitive training.

2. **Instruction**

- 2.1 The task of the NF is to select qualified persons who may be enrolled for instruction and qualification by the NFs for the International Judge's License. The number of International Judge's instructed by a NF is not limited.
- 2.2 For instruction and qualification, the NF must appoint a head instructor and two assistants who have the necessary specialized knowledge to instruct the applicants.
- 2.3 The instruction and qualification of applicants for the International Judge's License are to be carried out by the NF.
The instruction and qualification must be under the supervision of the NF in accordance with the lesson plan of these instruction regulations and must not be less than the prescribed 22 hours of instruction.
- 2.4 The period of instruction and qualification may not exceed six months measured from the beginning of instruction to the conclusion of the test.

3. Lesson Plan

- 3.1 All Sections of the IRO.
- 3.2 All Supplements of the IRO.
- 3.3 Practical work with measuring devices.
- 3.4 Working during a FIL competition with the assignment of special tasks and discussions.

4. Composition of the Examination Commission

- 4.1 FIL Proctor
- 4.2 Chairperson of the Examination Commission
- 4.3 First assistant to the chairperson
- 4.4 Second assistant to the chairperson

5. Responsibilities of the Examination Commission

- 5.1 An Examination Commission is appointed by the NF to administer the final examination of the applicants. As a rule, the head instructor should belong to this commission.
- 5.2 The chairperson of the Examination Commission must inform the FIL official responsible for the International Judges of the examination date at least eight (8) weeks in advance of the examination so that the FIL Proctor may be named and confirmed in writing to the NF. Expenses for the travel and accommodations of the FIL Proctor are assumed by the NF.
- 5.3 A record is to be made concerning the results of the examination and its execution. This report must include the signatures of the Examination Commission and the FIL Proctor with notation of the place and date of the examination.
- 5.4 The FIL Proctor has to send this record to the FIL official responsible for the International Judges.

6. Examination Regulations

- 6.1 The examination is given in written and oral form. The examination documents are available from the FIL official responsible for the International Judges.
- 6.2 The Examination Commission determines the length of time for the oral and written examination.
- 6.3 Candidates who use external aids during the examination which seriously put their knowledge or ability into question will be disqualified.
- 6.4 The examination is passed when the applicant responds correctly to at least three quarters of the posed questions.

7. Issuance of the International Judge License

- 7.1 The FIL Proctor issues the International Judge's License and the International Judge's Badge to the applicants in question after they have successfully passed the examination.
- 7.2 The FIL distributes the International Judge License in the form of a passport identification booklet signed by the FIL President.
- 7.3 The names of FIL International Judge's are entered in the FIL Directory of International Officials according to their names and National Federation.
- 7.4 The FIL member NFs must grant International Judges free entry to FIL competitions upon presentation of their identification card even if they are not working at the event(s).
- 7.5 The FIL Executive Board can withdraw the International Judge's License from a judge if he engages himself/herself in activities which harm the reputation of the FIL.

Supplement 3

Parallel Competition With Nations Cup

1. Definition

A parallel competition is one in which two athletes start simultaneously on race courses situated side by side.

In general, the courses should be sufficiently wide and possess the same terrain characteristics.

2. Selection and Preparation of the Course

2.1 A sufficiently wide, preferably slightly concave slope should be chosen for a parallel competition (this makes it possible to view the entire competition from each point).

If the inclination and ground elevations change, the entire width of the track must be included. The tracks must have the same profiles and same difficulties.

2.2 The race course has to be completely blocked off.

It is recommended to erect a second barrier along the course for coaches, athletes, and service personnel.

3. The Courses

3.1 A member of the Track Construction Commission must be present whenever a track is constructed. Construction of the track must be completed in a timely manner. The maximum length of the track is 300 m and the minimum width must be 3 m for each course.

3.2 The left race course (as seen from the top) is the red course and the right race course is the blue course. Both courses have to be marked as such.

4. Start

4.1 The start ramp must be constructed in such a way that the athletes can stand at the start comfortably and achieve full speed as soon as possible after the start.

4.2 In addition, the start facilities will be adapted to the requirements of the individual competitions.

The start gates have to open at the same time.

- Opening of the gates: - Electrical control
- The locking mechanism must be constructed with an electromagnetic switch assembly so that the opening of the swing gates (to the front) is triggered automatically.
 - This start system can also be operated manually.

4.3 The TD together with the starter will supervise the start.

In order to enable direct cooperation between the TD and the starter, a stand will be erected for the TD directly between, in front of, or behind the two swing gates, from where he/she can survey the entire race course.

The start signal may only be given after the TD has given his/her approval to the athletes to start.

4.4 It is possible to use either start system, provided that for both courses a fair start is guaranteed.

5. Start Command

- 5.1 Before the starter gives the command: "Achtung bereit" or "Ready set" and then triggers the start, he/she has to ask the athletes whether they are ready. This is done in an optional order: "Rot fertig", "Red ready" and "Blau fertig", "Blue ready".
The start command can be given only if the two athletes answer with „ja“ or „yes“.
- 5.2 If it can be proven that one or both gates were released due to a technical fault (not by touch of either athlete prior to when the start signal was given), the start will be repeated.
- 6. Finish**
- 6.1 The finish descents are to be symmetrical.
- 6.2 Each finish must have a banner suspended between 2 poles (finish line) and both finish gates must be at least 4m wide..
- 6.3 Due to safety reasons, the finish descents are separated optically.
- 7. Time-keeping**
- Due to a simultaneous start, only the time difference upon passing the finish will be registered with two independent time-keeping devices. The first athlete passing the finish triggers the timing system and receives the time of zero. The second athlete passing the finish, stops the timing system. The time difference is then measured in 1/100 of a second.
- 8. Staging of the Competition on Two Race Courses**
- The decision between each two athletes is done in two heats, whereby the two athletes change race courses for their second run.
- 8.1 Qualification**
- 8.1.1 Each athlete has one run on each race course.
- 8.1.2 The best 16 athletes (men) and 8 athletes (women) qualify for the parallel finals.
- 8.1.3 The athletes start according to their existing World Cup points.
- 8.1.4 In case of a tie in rank 8 or 16, the athletes involved do another run.
This run will be staged immediately after the qualifications.
This start order will be drawn.
- 8.1.5 A qualification list (time result list) will be made up.
- 8.2 Parallel finals**
- 8.2.1 8 groups (men) and 4 groups (women) are formed by taking the results from the qualification into consideration.
- 8.2.2 Groups:
- | | <u>Men</u> | <u>Women</u> |
|--|------------------|-----------------|
| | rank 1 - rank 16 | rank 1 - rank 8 |
| | rank 8 - rank 9 | |
| | rank 5 - rank 12 | rank 4 - rank 5 |
| | rank 4 - rank 13 | |
| | rank 3 - rank 14 | rank 3 - rank 6 |
| | rank 6 - rank 11 | |
| | rank 7 - rank 10 | |
| | rank 2 - rank 15 | rank 2 - rank 7 |
- 8.2.3 An athlete who does not finish his/her first run or drops out, starts the second run with a penalty time addition of 1.5 seconds (see point 8.6).

- 8.2.4 With each pairing, the athlete with the better qualification time starts the first heat on the red course. For the 2nd run, athletes swap courses. Each heat in the parallel finals will be run according to this system.
- 8.3 **Start Order**
- 8.3.1 The start is done according to the table from top to bottom; all pairs start following each other. The same system is used for all elimination rounds.
- 8.3.2
- | | | | |
|------------|-------|--|---------------|
| 1st round | men | 8 teams 1 st run | |
| 2nd round | men | 8 teams 2 nd run | |
| | | (Losers are ranked according to their times from 9 - 16) | |
| 3rd round | women | 4 teams 1 st run | |
| 4th round | men | 4 teams 1 st run | |
| 5th round | women | 4 teams 2 nd run | |
| | | (Losers are ranked according to their times from 5 - 8) | |
| 6th round | men | 4 teams 2 nd run | |
| | | (Losers are ranked according to their times from 5 - 8) | |
| 7th round | women | 2 teams 1 st run | |
| 8th round | men | 2 teams 1 st run | |
| 9th round | women | 2 teams 2 nd run | |
| | | (Losers in round 11 and 15) | |
| 10th round | men | 2 teams 2 nd run | |
| | | (Losers in round 12 and 16) | |
| 11th round | women | 1 team 1 st run (ranks 3 and 4) | |
| 12th round | men | 1 team 1 st run (ranks 3 and 4) | |
| 13th round | women | 1 team 1 st run (ranks 1 and 2) | |
| 14th round | men | 1 team 1 st run (ranks 1 and 2) | |
| 15th round | women | 1 team 2 nd run (ranks 3 and 4) | Finals |
| 16th round | men | 1 team 2 nd run (ranks 3 and 4) | Finals |
| 17th round | women | 1 team 2 nd run (ranks 1 and 2) | Finals |
| 18th round | men | 1 team 2 nd run (ranks 1 and 2) | Finals |
- 8.3.3 The ranks 5-8 and 9-16 are awarded according to the times achieved in the qualification runs. An athlete who qualified for another round remains in this round even if his/her qualification time was faster than the qualification time of one or several athletes in a worse group. (For example: if one is qualified for the round of the best 8, one stays in this group.)
- 8.3.4 The winners of each round move up to the next round until a winner is determined.
- 8.4 **Semi-finals and finals**
- 8.4.1 The four qualified athletes start in the order from round 7 until 18 (see point 8.2.2)
- 8.4.2 The losers of the pairs from round 7-10 have their 1st run for the ranks 2 and 4 prior to the 1st run of the participants in the finals. Then the losers of the 3rd elimination round have their 2nd run prior to the final race of the participants in the finals (see point 8.2.2).
- 8.5 **Disqualifications**
- 8.5.1 If there is a false start (early start) during a qualifying run, the athlete will be disqualified.
- 8.5.2 If an athlete crashes during a qualifying run and does not continue his/her run, the athlete will be eliminated from the race (DNF)
- 8.6 **Penalty Time added**
- 8.6.1 The penalty time added for women and men is 1,5 seconds.
- 8.6.2 If an athlete crashes during a final run, he/she will receive the simple penalty time added.
- 8.6.3 If there is a false start during a final run, the athlete will receive twice the penalty time added. If there is a tie between two athletes after the second run regarding their time difference, the winner of the second run moves up to the next round.

PARALLEL FINAL RUNS (Women)

PARALLEL COMPETITION
FINAL RUNS (Women)

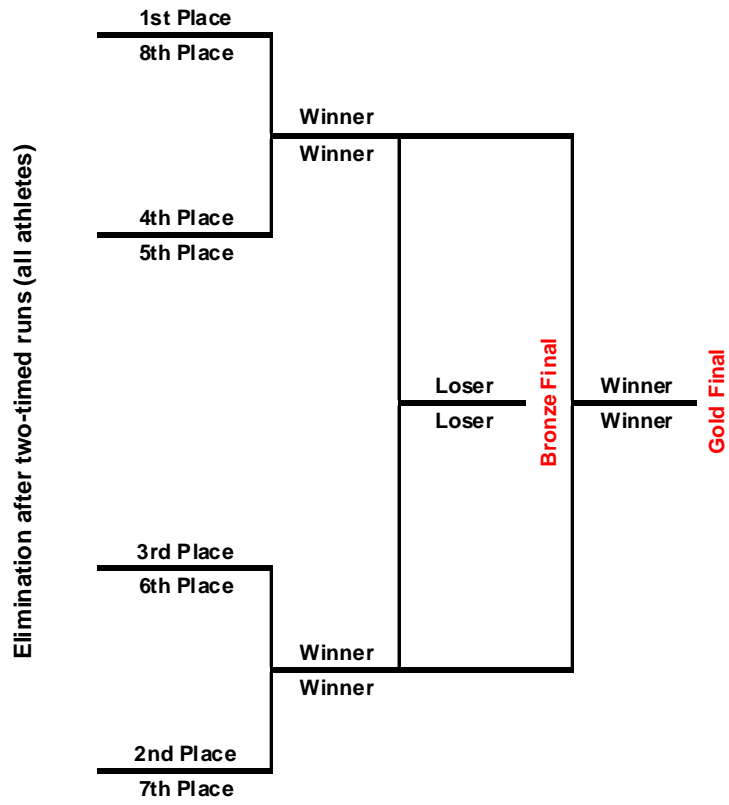

Supplement 5

Regulations for Audio-Visual Media Rights

1. **General**

- 1.1 The aim of the FIL is to promote the sport of luge worldwide. In order to come up to this challenge, it is necessary to establish uniform regulations for the coverage of the sport of luge via television, film, and other new media (for example internet), in order to achieve the best worldwide media presence.
- 1.2 If there are no other regulations, the FIL is the exclusive and worldwide owner of the rights for audio-visual media for all events taking place on behalf of or with the approval of the FIL. The following rights belong to the subject audio-visual media:
- television (free or Pay TV, all kinds of broadcasting, terrestrial, cable, satellite, etc.
 - film (all formats)
 - video (all systems including video games, etc.)
 - projection rights
 - movie and video pictures on the internet
- 1.3 If these regulations are not considered, the respective competition can be cancelled from the International FIL sport calendar for a certain period to be determined by the FIL Executive Board and/or it can result in sanctions against the respective NF.

2. **Awarding of Television Rights**

- 2.1 **International Competitions** (with the exception of championships)
- 2.1.1 The FIL authorizes the NFs affiliated with the FIL to conclude contracts on the awarding of the television rights which concern television broadcasts of luge events - except FIL Championships and Olympic Winter Games - which the Federation organizes in its country for the broadcasting area within its own country. The NF can delegate this responsibility to individual organizations belonging to the Federation. For the handing over of television rights to television companies outside the organizing country, the FIL is solely responsible.
- 2.1.2 Prior to signing them, all contract drafts are to be presented to the FIL for approval. The FIL can only withhold its approval for just cause. Just cause would be, if the contract partner cannot furnish production and/or broadcasting guarantees (in sufficient technical quality) and/or the contract partner does not provide an international live signal. If within six months prior to the event no detailed contract offer is presented, the FIL reserves the right to award the contract itself.
- 2.1.3 The NF or the event organizer authorized by the NF is obliged to grant the FIL free access to the live signal (signal with graphics and voice according to international standards).
- 2.2. **Championships**
Regarding agreement with television stations concerning the broadcasting rights of FIL Championships, the FIL Executive Board acts together with the organizing NF. The FIL Executive Board makes the final resolution.
- 2.3. **Olympic Winter Games**
Agreements regarding the broadcasting rights of the Olympic Winter Games are the responsibility of the IOC.

- 2.4. **Commentator Booths**
The NF or the event organizer authorized by the NF has to guarantee the FIL that sufficient commentator booths are available.

3. **Video, Film, and Other Rights**
After agreement by the FIL, the NF is authorized by the FIL to award the film and video rights in their own country as far as it is guaranteed that marketing these rights abroad is not possible.

4. **Short Reports**
The awarding of short report rights has to be done according to national and international regulations. If a respective request is made at the recording station, the FIL has to be informed at once.

5. **Financial Regulation**
 - 5.1 **Television**
For championships, the FIL is obliged to give two-thirds of the net income of the sales of the television rights (after deduction of possible taxes or other relevant expenses) to the organizing NF.
 - 5.2 **Video**
The FIL has to give two-thirds of the income of the selling of commercial film and video rights to the organizing national federation.

6. These regulations were acknowledged during the FIL Congress in Rome on June 24-25, 1994, and they were more precisely worded for the Congress in Colorado Springs in May 1998.

Supplement 6

Junior World Cup

Addition to § 2 IRO NT

- 1.3.2 Junior-World Cup (JWC) – at least 4 races
JWC races will include Junior I and Juniors II classes.
- 1.3.2.1 The number of races, the organizing venues and the dates will be proposed by the Natural Track Commission and confirmed by the Executive Board
- 1.3.2.2 The JWC has been initiated to support young talent in the natural track luge sport
- 1.3.2.3 Any athletes nominated by their NFs, their regional associations or clubs according to the rules (see § 3) are eligible to compete at JWC races.
- 1.3.2.4 Each event has to be held in two days
- 1.3.2.5 Training and competition runs: a Junior World cup consists of two training runs and two competition runs (doubles have only one training run):
- 1.3.2.6 The JWC can be held in the traditional „Downhill“ format, as a parallel race, or in other formats/tracks which have been approved by the FIL. Races on tracks of a minimum length of 350/400 meters are possible.
- 1.3.2.7 Award Ceremonies
The individual awards ceremonies with honorary trophies shall be provided by the organizers. The Overall Junior World Cup ceremony will be provided by the FIL. The FIL will provide medals and trophies for the medalists in the Overall Junior World Cup.
In all JWC award ceremonies the winners flag must be raised and their national anthem must be played.
- 1.3.2.8 Points will be awarded according to the IRO regulations of the world cup.
- 1.3.2.9 For each competition, the FIL appoints one Technical Delegate and the Jury Chair. In the first team captain's meeting two jury members shall be selected by the team captains.

Addition to § 3 IRO NT

- 3.6 There is no limit to the number of participants in the Junior I and Junior II classes in either the singles or doubles disciplines.
The organizers can include races for youth classes as well as the general class within the same event.

Supplement 7

World Cup with Nations Cup Natural Track

Competition Regulations Natural Track

World Cup eligibility per nation (including seeded athletes); maximum number of entries per nation; size of the field of participants.

	Women	Men	Doubles
Number of World Cup participants/nation	3	4	2
Maximum allowable entries/nation	5	7	4
Maximum number of participants/WC	15	25	12

Age Group Eligibility

In accordance with IRO §3, 4.3

For a competition taking place at the beginning of the season (July 1st - December 31st), the athlete falls in the age class valid for him/her during a competition held the following 1st of January.

Seeded Groups

- Women: For nations in 1st-7th place in the women's World Cup nations ranking, 1 woman per nation is seeded.
- Men: For nations in 1st-5th place in the men's World Cup nations ranking, 2 men per nation are seeded.
For nations in 6th-10th place in the men's World Cup nations ranking, 1 man per nation is seeded.
- Doubles: For nations in 1st- 5th place in the doubles' World Cup nations ranking, 1 double per nation is seeded.

The ranking of the nations will be reissued after 3 World Cup Races and at the beginning of each season, and the number of seeded athletes will be re-determined in all categories.

The current names of the seeded athletes in the respective groups are determined as follows:

Women from the nations in 1st-7th place in the last WC nations rankings women:

From the WC overall women's ranking after the last World Cup overall ranking.

In the case of a tie, the seeded athletes will be determined for the respective race as follows:

- -The faster run time in the qualification run counts.
- If there is a tie in the qualification run, the faster time in the training run counts.

If athletes are missing from the seeded group, other athletes are not moved up. The seeded positions are assigned based on the overall rankings as described above and are not transferable.

Men from the nations in 1st-5th place and 6th-10th place in the last WC nations rankings men:

From the WC overall men's ranking after the current World Cup overall ranking. In the case of a tie, the seeded athletes will be determined for the respective race as follows:

- The faster run time in the qualification run counts.
- If there is a tie in the qualification run, the faster time in the training run counts.

If athletes are missing from the seeded group, other athletes are not moved up. The seeded positions are assigned based on the overall rankings as described above and are not transferable

Doubles from the nations in 1st-5th place in the last WC nations rankings doubles:

From the WC overall doubles ranking from the last World Cup overall ranking.

In the case of a tie, the seeded athletes will be determined for the respective race as follows:

- The faster run time in the qualification run counts.
- If there is a tie in the qualification run, the faster time in the training run counts.

If athletes are missing from the seeded group, other athletes are not moved up. The seeded positions are assigned based on the overall rankings as described above and are not transferable. If there is a tie in the qualification run, the result from the training run counts in regards to the last start position.

Qualification race for the World Cup

The start order for the training and qualification runs is the reverse order of the last World Cup Nations Ranking for each discipline (all athletes from one nation start in a group, then the Nations one after the other).

The fastest women, men, and doubles from the qualification run are qualified for participation in the World Cup race in addition to the seeded athletes who are already qualified. The maximum allowed number of eligible athletes per nation in each discipline as well as the overall total may not be exceeded. The seeded athletes start jointly in the group as per their nation. The athletes keep the same start numbers during the entire WC event (WC + NC).

Participation in the Nations Cup race

All athletes who are eliminated in the qualification for the World Cup race participate in the Nations Cup race.

Rankings

World Cup

The following points are awarded per race for World Cup competition results:
See the IRO natural track §3.8.1.2

Team Competition

For the results garnered in a World Cup Team Competition, the following numbers of points are allocated per race for each team, and are included in the Nations ranking.
See the IRO Natural Track §3 8.1.2

Nations Cup

- Awarding of World Cup points:

Women

15 participants in the WC, independent of the starters in the WC: 1st Place in the Nations Cup is always = 25 World Cup Points etc. according to the table 8.1.2

Men

25 participants in the WC, independent of the starters in the WC: 1st Place in the Nations Cup is always = 15 World Cup Points etc. according to the table 8.1.2

Doubles

12 participants in the WC, independent of the starters in the WC:
1st Place in the Nations cup is always = 30 World Cup Points etc. according to the table 8.1.2

Only ranked athletes can receive points. No points for athletes who disqualify or crash.

Overall ranking according to Nation

The overall ranking according to country is derived from the athletes' individual results and the points in the team competition.

Supplement 8

Start Procedure Team Competition

1.1.1 Competition Procedure

- All three sleds of a Team Relay (woman, man, doubles) start from one start height one after the other.
- The first sled is cleared to start by the start leader by means of "READY SET". When the first athlete crosses the finish, they break the light barrier, triggering a contact to open the start gate. Timing continues to run.
- The second athlete can start as soon as the start gate has opened.
- The third and final athletes start in identical fashion as the second starter.
- When the third athletes cross the finish (light barrier), the timing stops and their total time for the Team Relay is transmitted.

1.1.2 Start order / Start preparations:

- The athlete enters the start area alone with his sport equipment and in the start position.
- No assistance from the coach is permitted.
- All that is allowed is the handing over of the sport equipment in the start area.

1.1.3 Start procedure:

- The athlete may start only when the start gate opens.

1.1.4 Start area:

- The start area is defined on every track by the TD and is marked.
- Coaches are not allowed in the defined start area.
- All radio equipment, phones or methods of communication for the purpose of informing the athletes are forbidden in the immediate start area.
- During the race, only the athlete starting next may enter the start area.
- Except for the race leader and the FIL representatives/judges, no other persons may stay in the start area.

1.1.5 False start:

- A FIL representative/Judge, who observes the start procedure both visually and technically, will note a false start and immediately notify the Race Director of any problems or violations.
- A false start occurs when the athlete in the start makes sufficient contact with the start gate to open it prior to it being triggered open by the athlete crossing the finish line.
- The team continues the race to the end independent of an ascertained false start.

1.1.6 Start equipment/start gate:

- The start gate is linked with the timing system. The technical equipment for the connection with the timing system at the finish must be provided through the organizer, as well as the anchoring of the start gate. The start area must be realized in accordance with the sketch.
- The start ramp must be prepared in accordance with the enclosed sketch.
- For the team competition, at least two wire pairs each with a 1.5 mm² cross sectional area are needed. (Start finish connection).
The FIL provides the start gate.

Enclosure: Sketch of the start ramp

Rennrodel auf Naturbahn - Luge on Natural Track
 Starttor Teambewerb - start gate team competition

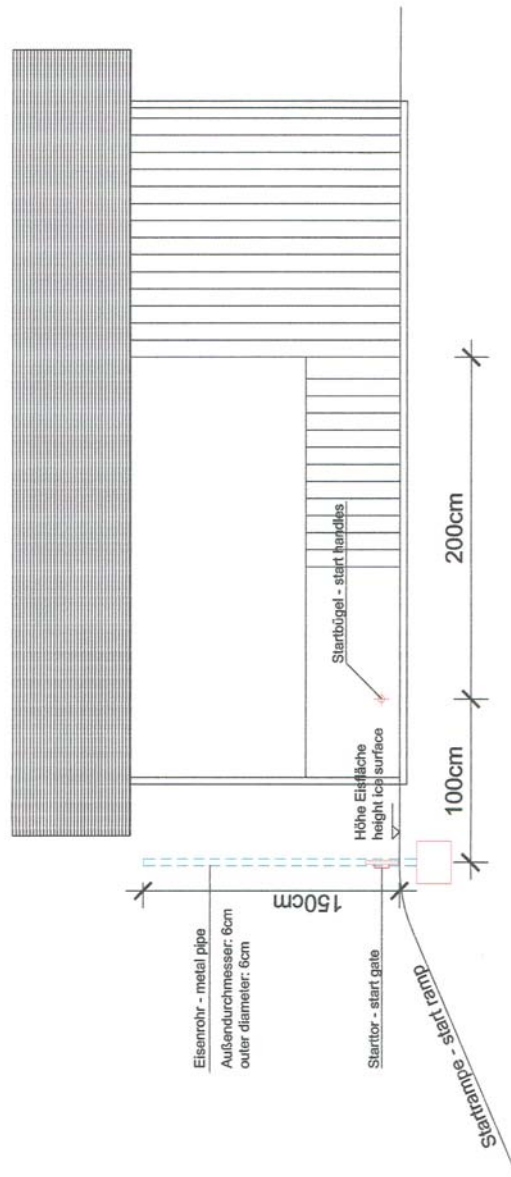

Renndrodel auf Naturbahn - Luge on Natural Track

Starttor Teambewerb - start gate team competition

